

100~250VAC				
CAP (MFD)	T ± 0.039" (± 1.0mm)	H ± 0.039" (± 1.0mm)	W ± 0.039" (± 1.0mm)	F ± 0.039" (± 1.0mm)
0.7	0.433" (11.0mm)	0.807" (20.5mm)	1.063" (27.0mm)	0.394" (10.0mm)
0.8	0.433" (11.0mm)	0.807" (20.5mm)	1.063" (27.0mm)	0.394" (10.0mm)
0.9	0.433" (11.0mm)	0.807" (20.5mm)	1.063" (27.0mm)	0.394" (10.0mm)
1.0	0.433" (11.0mm)	0.807" (20.5mm)	1.063" (27.0mm)	0.394" (10.0mm)
1.2	0.571" (14.5mm)	0.925" (23.5mm)	1.220" (31.0mm)	0.394" (10.0mm)
1.4	0.571" (14.5mm)	0.925" (23.5mm)	1.220" (31.0mm)	0.394" (10.0mm)
1.5	0.571" (14.5mm)	0.925" (23.5mm)	1.220" (31.0mm)	0.394" (10.0mm)
1.6	0.571" (14.5mm)	0.925" (23.5mm)	1.220" (31.0mm)	0.394" (10.0mm)
1.8	0.571" (14.5mm)	0.925" (23.5mm)	1.220" (31.0mm)	0.394" (10.0mm)
2.0	0.571" (14.5mm)	0.925" (23.5mm)	1.220" (31.0mm)	0.394" (10.0mm)
2.2	0.571" (14.5mm)	0.925" (23.5mm)	1.220" (31.0mm)	0.394" (10.0mm)
2.5	0.669" (17.0mm)	1.063" (27.0mm)	1.220" (31.0mm)	0.394" (10.0mm)
2.8	0.669" (17.0mm)	1.063" (27.0mm)	1.220" (31.0mm)	0.394" (10.0mm)
3.0	0.669" (17.0mm)	1.063" (27.0mm)	1.220" (31.0mm)	0.394" (10.0mm)
3.2	0.669" (17.0mm)	1.063" (27.0mm)	1.220" (31.0mm)	0.394" (10.0mm)
3.5	0.669" (17.0mm)	1.063" (27.0mm)	1.220" (31.0mm)	0.394" (10.0mm)
4.0	0.709" (18.0mm)	1.063" (27.0mm)	1.457" (37.0mm)	0.394" (10.0mm)
4.5	0.709" (18.0mm)	1.063" (27.0mm)	1.457" (37.0mm)	0.394" (10.0mm)
5.0	0.709" (18.0mm)	1.063" (27.0mm)	1.457" (37.0mm)	0.394" (10.0mm)
5.5	0.748" (19.0mm)	1.142" (29.0mm)	1.496" (38.0mm)	0.394" (10.0mm)
6.0	0.827" (21.0mm)	1.220" (31.0mm)	1.496" (38.0mm)	0.394" (10.0mm)
6.5	0.827" (21.0mm)	1.220" (31.0mm)	1.496" (38.0mm)	0.394" (10.0mm)

100~250VAC				
CAP (MFD)	T ± 0.039" (± 1.0mm)	H ± 0.039" (± 1.0mm)	W ± 0.039" (± 1.0mm)	F ± 0.039" (± 1.0mm)
7.0	0.827" (21.0mm)	1.220" (31.0mm)	1.496" (38.0mm)	0.394" (10.0mm)
7.5	0.748" (19.0mm)	1.142" (29.0mm)	1.890" (48.0mm)	0.394" (10.0mm)
8.0	0.748" (19.0mm)	1.142" (29.0mm)	1.890" (48.0mm)	0.394" (10.0mm)
8.5	0.827" (21.0mm)	1.220" (31.0mm)	1.890" (48.0mm)	0.394" (10.0mm)
9.0	0.827" (21.0mm)	1.220" (31.0mm)	1.890" (48.0mm)	0.394" (10.0mm)
9.5	0.827" (21.0mm)	1.220" (31.0mm)	1.890" (48.0mm)	0.394" (10.0mm)
10.0	0.886" (22.5mm)	1.240" (31.5mm)	1.890" (48.0mm)	0.394" (10.0mm)
11.0	0.827" (21.0mm)	1.220" (31.0mm)	2.283" (58.0mm)	0.394" (10.0mm)
12.0	0.827" (21.0mm)	1.220" (31.0mm)	2.283" (58.0mm)	0.394" (10.0mm)
13.0	0.866" (22.0mm)	1.378" (35.0mm)	2.283" (58.0mm)	0.394" (10.0mm)
14.0	0.866" (22.0mm)	1.378" (35.0mm)	2.283" (58.0mm)	0.394" (10.0mm)
15.0	0.925" (23.5mm)	1.457" (37.0mm)	2.283" (58.0mm)	0.591" (15.0mm)
16.0	0.925" (23.5mm)	1.457" (37.0mm)	2.283" (58.0mm)	0.591" (15.0mm)
17.0	0.925" (23.5mm)	1.457" (37.0mm)	2.283" (58.0mm)	0.591" (15.0mm)
18.0	0.925" (23.5mm)	1.457" (37.0mm)	2.283" (58.0mm)	0.591" (15.0mm)
19.0	1.142" (29.0mm)	1.614" (41.0mm)	2.283" (58.0mm)	0.591" (15.0mm)
20.0	1.142" (29.0mm)	1.614" (41.0mm)	2.283" (58.0mm)	0.591" (15.0mm)
21.0	1.142" (29.0mm)	1.614" (41.0mm)	2.283" (58.0mm)	0.591" (15.0mm)
22.0	1.142" (29.0mm)	1.614" (41.0mm)	2.283" (58.0mm)	0.591" (15.0mm)
23.0	1.142" (29.0mm)	1.614" (41.0mm)	2.283" (58.0mm)	0.591" (15.0mm)
24.0	1.142" (29.0mm)	1.614" (41.0mm)	2.283" (58.0mm)	0.591" (15.0mm)
25.0	1.142" (29.0mm)	1.614" (41.0mm)	2.283" (58.0mm)	0.591" (15.0mm)

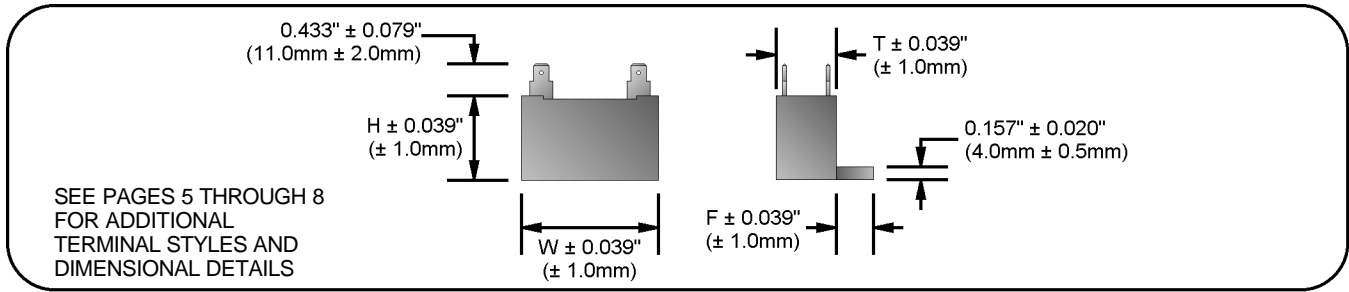

350VAC				
CAP (MFD)	T ± 0.039" (± 1.0mm)	H ± 0.039" (± 1.0mm)	W ± 0.039" (± 1.0mm)	F ± 0.039" (± 1.0mm)
0.5	0.433" (11.0mm)	0.807" (20.5mm)	1.063" (27.0mm)	0.394" (10.0mm)
0.55	0.571" (14.5mm)	0.925" (23.5mm)	1.220" (31.0mm)	0.394" (10.0mm)
0.6	0.571" (14.5mm)	0.925" (23.5mm)	1.220" (31.0mm)	0.394" (10.0mm)
0.7	0.571" (14.5mm)	0.925" (23.5mm)	1.220" (31.0mm)	0.394" (10.0mm)
0.8	0.571" (14.5mm)	0.925" (23.5mm)	1.220" (31.0mm)	0.394" (10.0mm)
0.9	0.571" (14.5mm)	0.925" (23.5mm)	1.220" (31.0mm)	0.394" (10.0mm)
1.0	0.571" (14.5mm)	0.925" (23.5mm)	1.220" (31.0mm)	0.394" (10.0mm)
1.2	0.571" (14.5mm)	0.925" (23.5mm)	1.220" (31.0mm)	0.394" (10.0mm)
1.4	0.669" (17.0mm)	1.063" (27.0mm)	1.220" (31.0mm)	0.394" (10.0mm)
1.5	0.669" (17.0mm)	1.063" (27.0mm)	1.220" (31.0mm)	0.394" (10.0mm)
1.6	0.669" (17.0mm)	1.063" (27.0mm)	1.220" (31.0mm)	0.394" (10.0mm)
1.8	0.709" (18.0mm)	1.063" (27.0mm)	1.457" (37.0mm)	0.394" (10.0mm)
2.0	0.709" (18.0mm)	1.063" (27.0mm)	1.457" (37.0mm)	0.394" (10.0mm)
2.2	0.709" (18.0mm)	1.063" (27.0mm)	1.457" (37.0mm)	0.394" (10.0mm)
2.5	0.748" (19.0mm)	1.142" (29.0mm)	1.496" (38.0mm)	0.394" (10.0mm)
2.8	0.827" (21.0mm)	1.220" (31.0mm)	1.496" (38.0mm)	0.394" (10.0mm)
3.0	0.827" (21.0mm)	1.220" (31.0mm)	1.496" (38.0mm)	0.394" (10.0mm)

350VAC				
CAP (MFD)	T ± 0.039" (± 1.0mm)	H ± 0.039" (± 1.0mm)	W ± 0.039" (± 1.0mm)	F ± 0.039" (± 1.0mm)
3.2	0.827" (21.0mm)	1.220" (31.0mm)	1.496" (38.0mm)	0.394" (10.0mm)
3.5	0.748" (19.0mm)	1.142" (29.0mm)	1.890" (48.0mm)	0.394" (10.0mm)
4.0	0.827" (21.0mm)	1.220" (31.0mm)	1.890" (48.0mm)	0.394" (10.0mm)
4.5	0.827" (21.0mm)	1.220" (31.0mm)	1.890" (48.0mm)	0.394" (10.0mm)
5.0	0.886" (22.5mm)	1.240" (31.5mm)	1.890" (48.0mm)	0.394" (10.0mm)
5.5	0.827" (21.0mm)	1.220" (31.0mm)	2.283" (58.0mm)	0.394" (10.0mm)
6.0	0.827" (21.0mm)	1.220" (31.0mm)	2.283" (58.0mm)	0.394" (10.0mm)
6.5	0.866" (22.0mm)	1.378" (35.0mm)	2.283" (58.0mm)	0.394" (10.0mm)
7.0	0.866" (22.0mm)	1.378" (35.0mm)	2.283" (58.0mm)	0.394" (10.0mm)
7.5	0.925" (23.5mm)	1.457" (37.0mm)	2.283" (58.0mm)	0.591" (15.0mm)
8.0	0.925" (23.5mm)	1.457" (37.0mm)	2.283" (58.0mm)	0.591" (15.0mm)
8.5	0.925" (23.5mm)	1.457" (37.0mm)	2.283" (58.0mm)	0.591" (15.0mm)
9.0	0.925" (23.5mm)	1.457" (37.0mm)	2.283" (58.0mm)	0.591" (15.0mm)
9.5	1.142" (29.0mm)	1.614" (41.0mm)	2.283" (58.0mm)	0.591" (15.0mm)
10.0	1.142" (29.0mm)	1.614" (41.0mm)	2.283" (58.0mm)	0.591" (15.0mm)
11.0	1.142" (29.0mm)	1.614" (41.0mm)	2.283" (58.0mm)	0.591" (15.0mm)
12.0	1.142" (29.0mm)	1.614" (41.0mm)	2.283" (58.0mm)	0.591" (15.0mm)

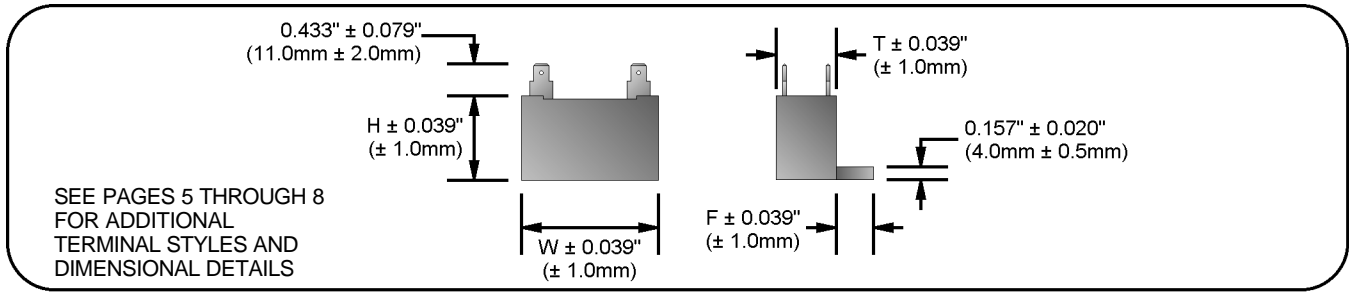

400VAC				
CAP (MFD)	T ± 0.039" (± 1.0mm)	H ± 0.039" (± 1.0mm)	W ± 0.039" (± 1.0mm)	F ± 0.039" (± 1.0mm)
0.3	0.433" (11.0mm)	0.807" (20.5mm)	1.063" (27.0mm)	0.394" (10.0mm)
0.4	0.433" (11.0mm)	0.807" (20.5mm)	1.063" (27.0mm)	0.394" (10.0mm)
0.45	0.433" (11.0mm)	0.807" (20.5mm)	1.063" (27.0mm)	0.394" (10.0mm)
0.5	0.571" (14.5mm)	0.925" (23.5mm)	1.220" (31.0mm)	0.394" (10.0mm)
0.55	0.571" (14.5mm)	0.925" (23.5mm)	1.220" (31.0mm)	0.394" (10.0mm)
0.6	0.571" (14.5mm)	0.925" (23.5mm)	1.220" (31.0mm)	0.394" (10.0mm)
0.7	0.571" (14.5mm)	0.925" (23.5mm)	1.220" (31.0mm)	0.394" (10.0mm)
0.8	0.571" (14.5mm)	0.925" (23.5mm)	1.220" (31.0mm)	0.394" (10.0mm)
0.9	0.571" (14.5mm)	0.925" (23.5mm)	1.220" (31.0mm)	0.394" (10.0mm)
1.0	0.669" (17.0mm)	1.063" (27.0mm)	1.220" (31.0mm)	0.394" (10.0mm)
1.2	0.669" (17.0mm)	1.063" (27.0mm)	1.220" (31.0mm)	0.394" (10.0mm)
1.4	0.669" (17.0mm)	1.063" (27.0mm)	1.220" (31.0mm)	0.394" (10.0mm)
1.5	0.709" (18.0mm)	1.063" (27.0mm)	1.457" (37.0mm)	0.394" (10.0mm)
1.6	0.709" (18.0mm)	1.063" (27.0mm)	1.457" (37.0mm)	0.394" (10.0mm)
1.8	0.709" (18.0mm)	1.063" (27.0mm)	1.457" (37.0mm)	0.394" (10.0mm)
2.0	0.748" (19.0mm)	1.142" (29.0mm)	1.496" (38.0mm)	0.394" (10.0mm)
2.2	0.827" (21.0mm)	1.220" (31.0mm)	1.496" (38.0mm)	0.394" (10.0mm)

400VAC				
CAP (MFD)	T ± 0.039" (± 1.0mm)	H ± 0.039" (± 1.0mm)	W ± 0.039" (± 1.0mm)	F ± 0.039" (± 1.0mm)
2.5	0.827" (21.0mm)	1.220" (31.0mm)	1.496" (38.0mm)	0.394" (10.0mm)
2.8	0.748" (19.0mm)	1.142" (29.0mm)	1.890" (48.0mm)	0.394" (10.0mm)
3.0	0.827" (21.0mm)	1.220" (31.0mm)	1.890" (48.0mm)	0.394" (10.0mm)
3.2	0.827" (21.0mm)	1.220" (31.0mm)	1.890" (48.0mm)	0.394" (10.0mm)
3.5	0.886" (22.5mm)	1.240" (31.5mm)	1.890" (48.0mm)	0.394" (10.0mm)
4.0	0.827" (21.0mm)	1.220" (31.0mm)	2.283" (58.0mm)	0.394" (10.0mm)
4.5	0.866" (22.0mm)	1.378" (35.0mm)	2.283" (58.0mm)	0.394" (10.0mm)
5.0	0.925" (23.5mm)	1.457" (37.0mm)	2.283" (58.0mm)	0.591" (15.0mm)
5.5	0.925" (23.5mm)	1.457" (37.0mm)	2.283" (58.0mm)	0.591" (15.0mm)
6.0	0.925" (23.5mm)	1.457" (37.0mm)	2.283" (58.0mm)	0.591" (15.0mm)
6.5	0.925" (23.5mm)	1.457" (37.0mm)	2.283" (58.0mm)	0.591" (15.0mm)
7.0	1.142" (29.0mm)	1.614" (41.0mm)	2.283" (58.0mm)	0.591" (15.0mm)
7.5	1.142" (29.0mm)	1.614" (41.0mm)	2.283" (58.0mm)	0.591" (15.0mm)
8.0	1.142" (29.0mm)	1.614" (41.0mm)	2.283" (58.0mm)	0.591" (15.0mm)
8.5	1.142" (29.0mm)	1.614" (41.0mm)	2.283" (58.0mm)	0.591" (15.0mm)
9.0	1.142" (29.0mm)	1.614" (41.0mm)	2.283" (58.0mm)	0.591" (15.0mm)

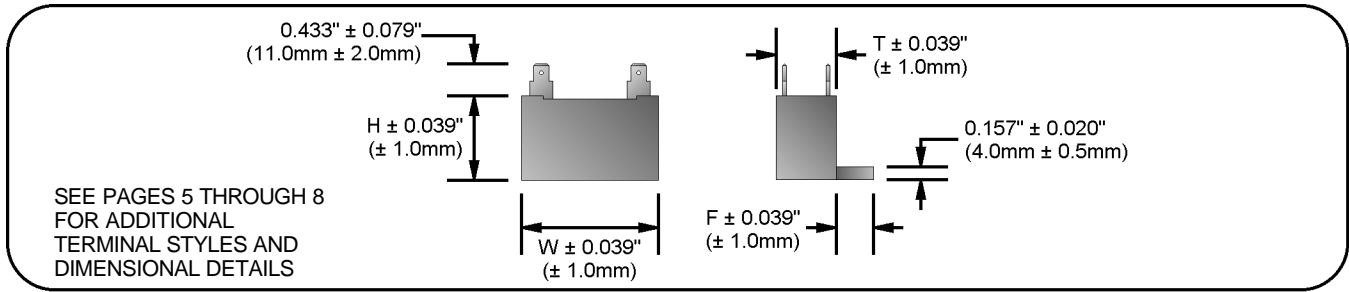

450VAC				
CAP (MFD)	T ± 0.039" (± 1.0mm)	H ± 0.039" (± 1.0mm)	W ± 0.039" (± 1.0mm)	F ± 0.039" (± 1.0mm)
0.2	0.433" (11.0mm)	0.807" (20.5mm)	1.063" (27.0mm)	0.394" (10.0mm)
0.3	0.433" (11.0mm)	0.807" (20.5mm)	1.063" (27.0mm)	0.394" (10.0mm)
0.4	0.571" (14.5mm)	0.925" (23.5mm)	1.220" (31.0mm)	0.394" (10.0mm)
0.45	0.571" (14.5mm)	0.925" (23.5mm)	1.220" (31.0mm)	0.394" (10.0mm)
0.5	0.571" (14.5mm)	0.925" (23.5mm)	1.220" (31.0mm)	0.394" (10.0mm)
0.55	0.571" (14.5mm)	0.925" (23.5mm)	1.220" (31.0mm)	0.394" (10.0mm)
0.6	0.669" (17.0mm)	1.063" (27.0mm)	1.220" (31.0mm)	0.394" (10.0mm)
0.7	0.669" (17.0mm)	1.063" (27.0mm)	1.220" (31.0mm)	0.394" (10.0mm)
0.8	0.669" (17.0mm)	1.063" (27.0mm)	1.220" (31.0mm)	0.394" (10.0mm)
0.9	0.669" (17.0mm)	1.063" (27.0mm)	1.220" (31.0mm)	0.394" (10.0mm)
1.0	0.709" (18.0mm)	1.063" (27.0mm)	1.457" (37.0mm)	0.394" (10.0mm)
1.2	0.709" (18.0mm)	1.063" (27.0mm)	1.457" (37.0mm)	0.394" (10.0mm)
1.4	0.748" (19.0mm)	1.142" (29.0mm)	1.496" (38.0mm)	0.394" (10.0mm)
1.5	0.827" (21.0mm)	1.220" (31.0mm)	1.496" (38.0mm)	0.394" (10.0mm)
1.6	0.827" (21.0mm)	1.220" (31.0mm)	1.496" (38.0mm)	0.394" (10.0mm)
1.8	0.748" (19.0mm)	1.142" (29.0mm)	1.890" (48.0mm)	0.394" (10.0mm)

450VAC				
CAP (MFD)	T ± 0.039" (± 1.0mm)	H ± 0.039" (± 1.0mm)	W ± 0.039" (± 1.0mm)	F ± 0.039" (± 1.0mm)
2.0	0.748" (19.0mm)	1.142" (29.0mm)	1.890" (48.0mm)	0.394" (10.0mm)
2.2	0.748" (19.0mm)	1.142" (29.0mm)	1.890" (48.0mm)	0.394" (10.0mm)
2.5	0.827" (21.0mm)	1.220" (31.0mm)	1.890" (48.0mm)	0.394" (10.0mm)
2.8	0.886" (22.5mm)	1.240" (31.5mm)	1.890" (48.0mm)	0.394" (10.0mm)
3.0	0.827" (21.0mm)	1.220" (31.0mm)	2.283" (58.0mm)	0.394" (10.0mm)
3.2	0.827" (21.0mm)	1.220" (31.0mm)	2.283" (58.0mm)	0.394" (10.0mm)
3.5	0.866" (22.0mm)	1.378" (35.0mm)	2.283" (58.0mm)	0.394" (10.0mm)
4.0	0.866" (22.0mm)	1.378" (35.0mm)	2.283" (58.0mm)	0.394" (10.0mm)
4.5	0.925" (23.5mm)	1.457" (37.0mm)	2.283" (58.0mm)	0.591" (15.0mm)
5.0	0.925" (23.5mm)	1.457" (37.0mm)	2.283" (58.0mm)	0.591" (15.0mm)
5.5	0.925" (23.5mm)	1.457" (37.0mm)	2.283" (58.0mm)	0.591" (15.0mm)
6.0	1.142" (29.0mm)	1.614" (41.0mm)	2.283" (58.0mm)	0.591" (15.0mm)
6.5	1.142" (29.0mm)	1.614" (41.0mm)	2.283" (58.0mm)	0.591" (15.0mm)
7.0	1.142" (29.0mm)	1.614" (41.0mm)	2.283" (58.0mm)	0.591" (15.0mm)
7.5	1.142" (29.0mm)	1.614" (41.0mm)	2.283" (58.0mm)	0.591" (15.0mm)
8.0	1.142" (29.0mm)	1.614" (41.0mm)	2.283" (58.0mm)	0.591" (15.0mm)

OUTLINE DRAWINGS

MOUNTING FOOT STYLES

THE FOLLOWING DIAGRAMS INDICATE MOUNTING FOOT AND MOUNTING HOLE SIZES AND POSITIONS FOR THE GIVEN CASE SIZES. CASES MAY BE ORDERED WITHOUT A MOUNTING FOOT BY ADDING "(N)" TO THE END OF THE FAMILY NAME. (i.e. CMPP-F(N))

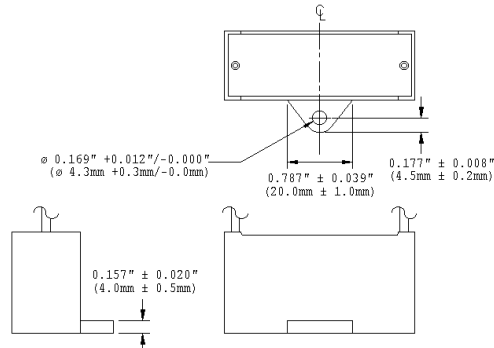

**Case size 0.827"X1.220"X2.283"
(21mmx31mmx58mm) and below**

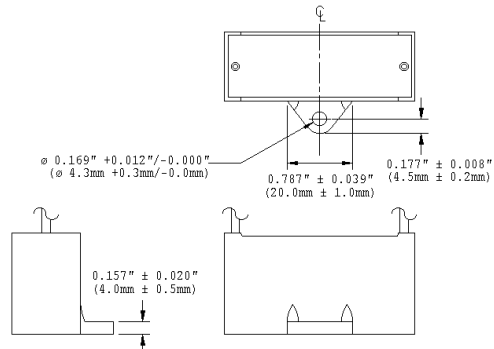

**Case size 0.866"X1.378"X2.283"
(22mmx35mmx58mm) only**

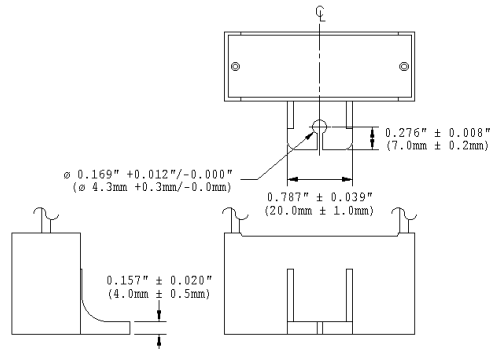

**Case size 0.925"X1.457"X2.283"
(23.5mmx37mmx58mm) and above**

OUTLINE DRAWINGS (cont.)

TERMINAL STYLES

THE FOLLOWING DIAGRAMS INDICATE TERMINAL SIZES AND POSITIONS FOR AVAILABLE TERMINAL STYLES. STYLE "V" IS THE DEFAULT TERMINAL STYLE USED BY ASC. TERMINAL STYLE MUST BE INDICATED ON ORDERS.

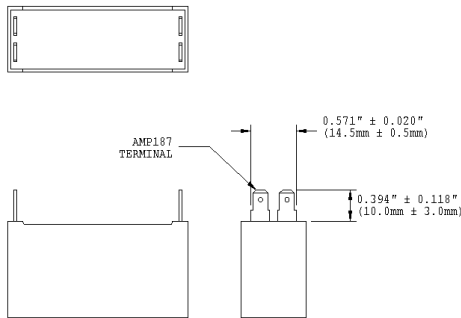

Terminal style A (AMP187)

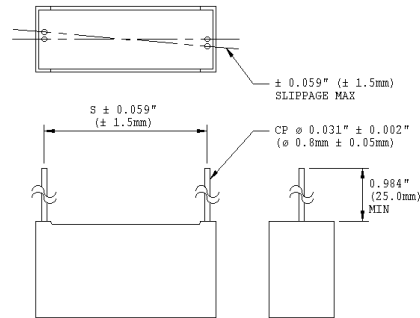

Terminal style F (steel wire)

L	S
1.220" (31.0mm)	1.043" (26.5mm)
1.457" (37.0mm)	1.280" (32.5mm)
1.496" (38.0mm)	1.299" (33.0mm)
1.890" (48.0mm)	1.693" (43.0mm)
2.283" (58.0mm)	2.087" (53.0mm)

DIMENSION "S"

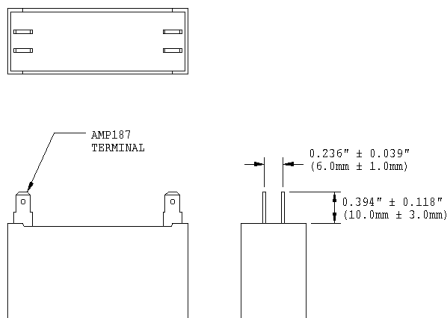

Terminal style M (AMP187)

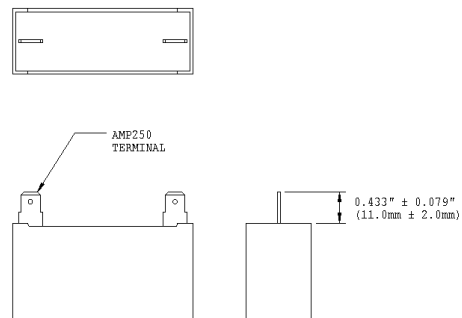

Terminal style T (AMP250)

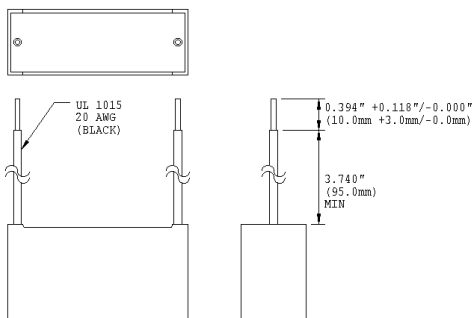

Terminal style U (insulated wire)

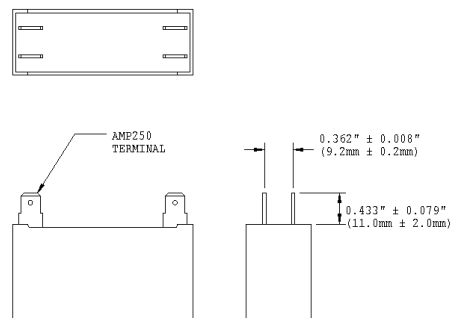

Terminal style V (AMP250)

OUTLINE DRAWINGS (cont.)

TERMINAL STYLES

THE FOLLOWING DIAGRAMS INDICATE TERMINAL SIZES AND POSITIONS FOR AVAILABLE TERMINAL STYLES. STYLE "V" IS THE DEFAULT TERMINAL STYLE USED BY ASC. TERMINAL STYLE MUST BE INDICATED ON ORDERS.

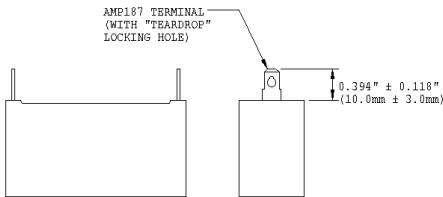

Terminal style W (AMP187)

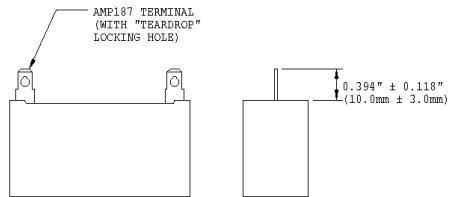

Terminal style X (AMP187)

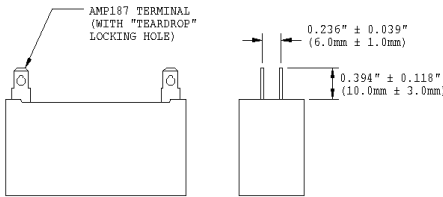

Terminal style Y (AMP187)

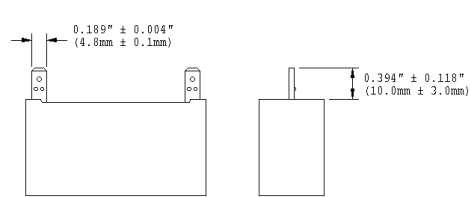

Terminal style 1 (DIN)

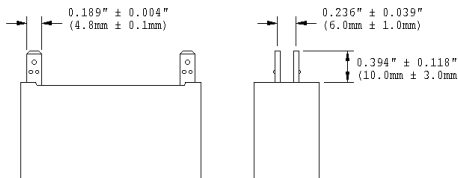

Terminal style 2 (DIN)

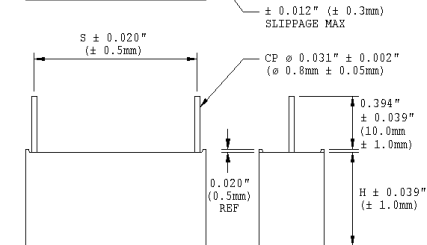

**Terminal style 8 (TCW wire)
Maximum case size 0.866"x1.378"x2.283"
(22mmx35mmx58mm)**

L	S
1.220" (31.0mm)	1.043" (26.5mm)
1.457" (37.0mm)	1.280" (32.5mm)
1.496" (38.0mm)	1.299" (33.0mm)
1.890" (48.0mm)	1.693" (43.0mm)
2.283" (58.0mm)	2.087" (53.0mm)

DIMENSION "S"

GENERAL SPECIFICATIONS

PHYSICAL CHARACTERISTICS

CONSTRUCTION: NON-INDUCTIVE WOUND METALLIZED POLYPROPYLENE.

CASE: FLAME RETARDANT PREFORMED CASE WITH EPOXY FILL.

LEAD MATERIAL: AMP187, AMP250, SOLID WIRE, DIN SOLDER TABS, AND STRANDED WIRE AVAILABLE IN VARIOUS CONFIGURATIONS. SEE PAGES 6 AND 7 FOR DETAILS ON AVAILABLE CONFIGURATIONS.

DIMENSIONS: AS SPECIFIED IN TABLES. MOUNTING FOOT DIMENSIONS DEPENDENT UPON CASE SIZE. SEE PAGE 5 FOR DETAILS ON MOUNTING FOOT DIMENSIONS. ALL DIMENSIONS ARE MEASURED AT THE BOTTOM SIDE OF THE CASE.

ELECTRICAL CHARACTERISTICS

CAPACITANCE: AS SPECIFIED IN TABLES \pm REQUESTED TOLERANCE WHEN MEASURED AT OR REFERRED TO 1000 \pm 20 Hz AND 25 \pm 5 °C.

TOLERANCE: \pm 5% AND \pm 10% AVAILABLE. OTHER TOLERANCES AVAILABLE UPON REQUEST.

DISSIPATION FACTOR: SHALL NOT BE GREATER THAN 0.2% WHEN MEASURED AT OR REFERRED TO 60 \pm 10 Hz AND 25 \pm 5 °C.

DIELECTRIC STRENGTH: 175% RATED VOLTAGE FOR 1 MINUTE AT 25 \pm 5 °C.

RATED VOLTAGE: 100~250VAC, 350VAC, 400VAC, AND 450VAC AVAILABLE. RATED FOR OPERATION AT 50/60 Hz ONLY.

TEMPERATURE: -25 °C TO +85 °C AT FULL RATED VOLTAGE.

ADDITIONAL INFORMATION

ORDERING INFORMATION: PARTS MAY BE ORDERED WITH EITHER THE "CMPP" OR "X347" PART NUMBER. REGARDLESS OF PART NUMBER ORDERED, ALL PARTS WILL BE MARKED WITH THE "CMPP" PART NUMBER. ALL ASC CAPACITORS ARE ORDERED BY "FAMILY CAP-TOL-VOLT" DESIGNATION. TERMINAL STYLE AND MOUNTING FOOT OPTION MUST ALSO BE INDICATED. (I.E. TO ORDER A CMPP 5 μ F, \pm 10%, 350VAC CAPACITOR WITH STYLE V TERMINALS AND NO MOUNTING FOOT, REQUEST PART NUMBER "CMPP-V (N) 5-10-350". TO ORDER THE SAME PART WITH A MOUNTING FOOT, REQUEST PART NUMBER "CMPP-V 5-10-350".)

WARNING: INFORMATION ON THIS FILE IS SUBJECT TO CHANGE WITHOUT NOTICE AT ASC'S DISCRETION.

LAST MODIFIED: 09/14/01